

# KOBE® KOBE Range Hoods

## Brillia Series

### CHX81 SQB-X Series

Model No.: CHX8130SQB-1 (30") / CHX8136SQB-1 (36")  
CHX8130SQB-2 (30") / CHX8136SQB-2 (36")

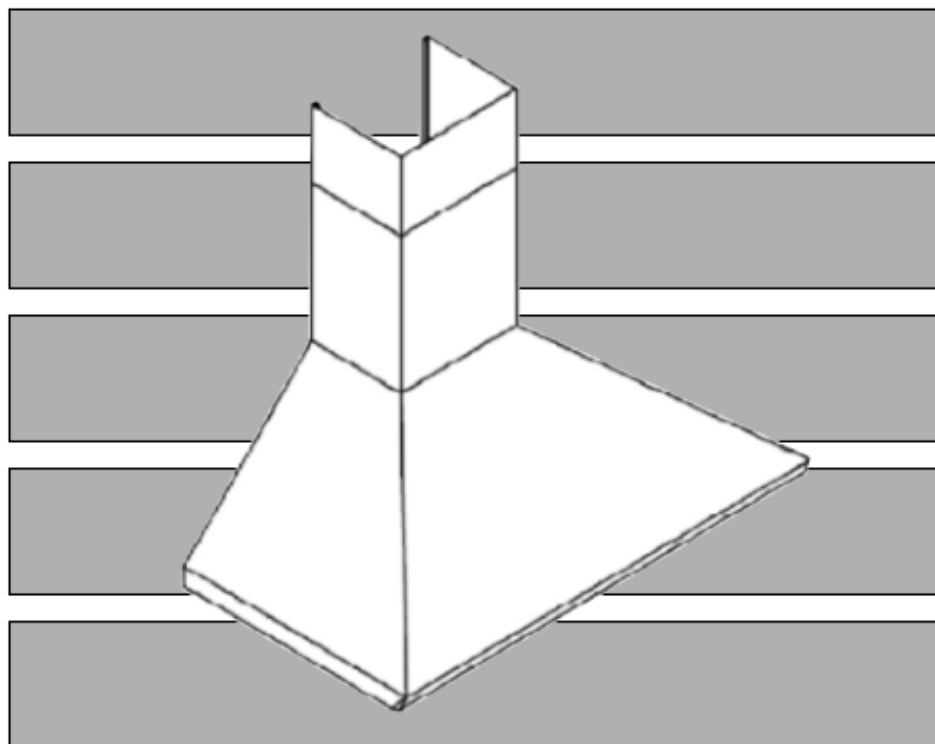

INSTALLATION INSTRUCTIONS  
AND OPERATION MANUAL

# IMPORTANT READ THIS FIRST

## READ BEFORE INSTALLATION

1. Carefully check all contents of package(s).
2. Thoroughly inspect the unit for any shipping damages, cosmetic damages or defects.
3. Have a certified contractor/electrician test the unit before installation.

## IF THERE IS ANY PROBLEMS:

1. **DO NOT INSTALL THE UNIT AND KEEP ALL ORIGINAL PACKAGING MATERIALS.**
2. Have your original invoice as proof of purchase and product serial number ready.
3. Contact your merchant for product replacement due to shipping damages, cosmetic damages or defects.
4. For all other issues, email [customer.service@koberangehoods.com](mailto:customer.service@koberangehoods.com).

## NO RETURN, NO REFUND, NO EXCHANGE IF:

1. PRODUCT HAS BEEN INSTALLED
2. KNOCK-OUT HOLES HAVE BEEN PUNCTURED
3. MISSING ORIGINAL PACKAGING MATERIAL AND/OR PARTS

# [ENGLISH]

- READ AND SAVE THESE INSTRUCTIONS -

## CONTENTS

IMPORTANT SAFETY INSTRUCTIONS .....	1
COMPONENTS OF PACKAGE .....	3
INSTALLATION.....	4
OPERATING INSTRUCTIONS .....	7
MAINTENANCE .....	8
SPECIFICATIONS .....	9
MEASUREMENTS & DIAGRAMS.....	10
PARTS LIST .....	11
CIRCUIT DIAGRAM.....	12
TROUBLE SHOOTING .....	13
WARRANTY .....	14
WARRANTY INFORMATION FORM .....	16

- READ ALL INSTRUCTIONS CAREFULLY BEFORE STARING -

ALL WIRING MUST BE DONE BY A PROFESSIONAL AND  
IN ACCORDANCE WITH NATIONAL AND LOCAL ELECTRICAL CODES



Control Number: 5011098

## IMPORTANT SAFETY INSTRUCTIONS

- PLEASE READ THIS SECTION CAREFULLY BEFORE INSTALLATION -

**⚠ WARNING:** TO REDUCE THE RISK OF FIRE, ELECTRIC SHOCK OR PERSONAL INJURY, OBSERVE THE FOLLOWING:

1. Installation and electrical wiring must be done by qualified professionals and in accordance with all applicable codes and standards, including fire-rated construction.
2. When cutting or drilling into wall or ceiling, be careful not to damage electrical wiring or other hidden utilities.
3. Ducted fans must be vented to the outside.
  - a. Before servicing or cleaning unit, open the light panel and SWITCH POWR OFF AT SERVICE PANEL.
  - b. Clean all grease laden surfaces frequently. To reduce the risk of fire and to disperse air properly, make sure to vent air outside. DO NOT vent exhaust air into wall spaces, attics, crawl spaces or garages.

NOTE - This warranty is void without an authorized agent's receipt or if unit is damaged due to misuse, poor installation, improper use, mistreatment, negligence or any other circumstances beyond the control of KOBE authorized agents. Any repair carried out without the supervision of KOBE authorized agents automatically void the warranty.

- KOBE will not be held responsible for any damages to personal property or real estate or any bodily injuries whether caused directly or indirectly by the range hood.

**⚠ WARNING:** TO REDUCE THE RISK OF PERSONAL INJURY IN THE EVENT OF A RANGE TOP GREASE FIRE:

1. Keep all fan, baffle/spacer/filter/oil tunnel/oil container and grease-laden surfaces clean. Grease should not be allowed to accumulate on fan, baffle/spacer/filter/oil tunnel/oil container.
2. Always turn hood ON when cooking.
3. Use high setting on cooking range ONLY when necessary.
4. Do not leave cooking range unattended when cooking.
5. Always use cookware and utensils appropriate for the type and amount of food prepared.
6. Use this unit only in the manner intended by the manufacturer.
7. Before servicing, switch power off at service panel and lock service panel (if possible) to prevent power from switching on accidentally.
8. Clean ventilating fan frequently.

## **What to Do in the Event of a Range Top Grease Fire**

1. SMOTHER FLAMES with a tight fitting lid, cookie sheet, or metal tray, and then turn off the burner. KEEP FLAMMABLE OR COMBUSTIBLE MATERIAL AWAY FROM FLAMES. If the flames do not go out immediately, EVACUATE THE AREA AND CALL THE FIRE DEPARTMENT or 911.
2. NEVER PICK UP A BURNING PAN – You May Get Burned.
3. DO NOT USE WATER, including wet dishcloths or towels – a steam blast will result.
4. Use an extinguisher ONLY if:
  - a. You have a Class A, B, C extinguisher and know how to operate it.
  - b. The fire is small and contained in the area where it started.
  - c. The fire department has been called.
  - d. You can fight the fire with your back to an exit.

## **What to Do If You Smell Gas**

1. Extinguish any open flame.
2. Do not try to turn on the lights or any type of appliance.
3. Open all doors and windows to disperse the gas. If you still smell gas, call the Gas Company and Fire Department right away.

## **CAUTION**

1. For general ventilation use only. Do not use to exhaust hazardous or explosive materials and vapors.
2. To reduce the risk of fire, use only metal ductwork. Sufficient air is needed for proper combustion and exhausting of gases through the flue (chimney) to prevent back drafting.
3. Follow the heating equipment manufacturer's guideline and safety standards such as those published by the National Fire Protection Association (NFPA), and the American Society for Heating, Refrigeration and Air Conditioning Engineers (ASHRAE), and code authorities.
4. Activating any switch on may cause ignition or an explosion.
5. Due to the size and weight of this hood, installation by 2 persons is recommended.

### **WARNING**



**ELECTRICAL SHOCK HAZARD – Can result in serious injury or death. Disconnected appliance from electric power before servicing. If equipped, the fluorescent light bulb contains small amounts of mercury, which must be recycled or disposed of according to Local, State, and Federal Codes.**

# COMPONENTS OF PACKAGE

(Must keep all materials for returns or refunds)

## Range Hood Box

- {A} KOBE Range Hood
- {B} Warranty Registration Card
- {C} Quick Reference Guide
- {D} 6" Round Exhaust with Rubber Plate x 1
- {E} Baffle Filter x 2 (for 30" hood)  
x 3 (for 36" hood)
- {F} Duct Cover-Mounting Bracket x 1
- {G} Flapper x 2
- {H} Screws Package

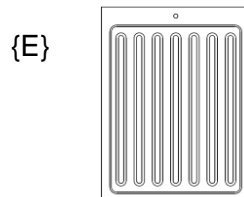
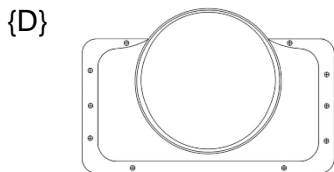
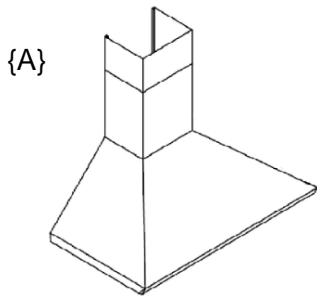

\*knob is attached to the filters

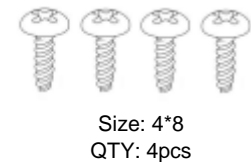
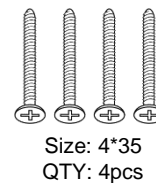
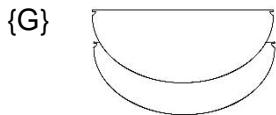
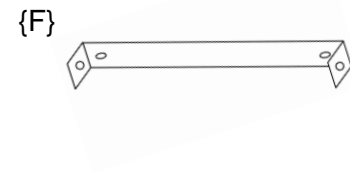

- FOR MORE INFORMATION, PLEASE VISIT OUR WEBSITE [www.koberangehoods.com](http://www.koberangehoods.com) OR CONTACT KOBE RANGE HOODS [customer.service@koberangehoods.com](mailto:customer.service@koberangehoods.com).

## INSTALLATION

PLEASE READ THE ENTIRE INSTRUCTIONS BEFORE PROCEEDING

### Calculation before Installation

To calculate installation, please refer to TABLE 1. (All calculation is measured in inches).

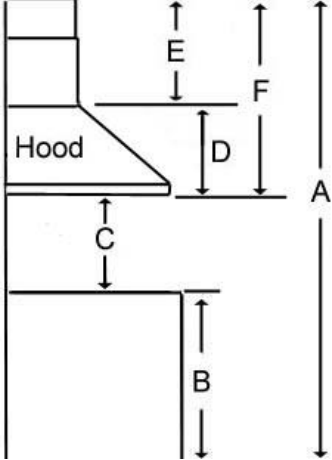
TABLE 1	
<p>A = Height of Floor to Ceiling B = Height of Floor to Counter Top (Standard: 36") C = Preferred Height of Counter Top to Hood Bottom (Recommended 26" to 30") D = Height of Hood E = Height of Duct cover [F – D] F = Height of the Hood Installation [A – (B+C)]</p>	

### **SAFETY WARNING**

- HOOD MAY HAVE SHARP EDGES; PLEASE WEAR PROTECTIVE GLOVES IF REMOVING ANY PARTS FOR INSTALLING, CLEANING, OR SERVICING.
- BE CAREFUL WHEN USING ELECTRICAL SCREWDRIVER, DAMAGE TO THE HOOD MAY OCCUR. USING HAND TOOLS IS RECOMMENDED. DO NOT OVER TIGHTEN SCREWS.
- MAKE SURE TO PREVENT ANY DEBRIS FROM ENTERING THE VENT OPENING TO AVOID DAMAGE OR MALFUCTIONS.

## WALL MOUNT INSTALLATION

### Before Installation

1. Read any provided document(s).
2. Test the range hood by temporarily connecting it to an outlet and turning ON the fan and lights.
3. If you run into any problems, contact KOBE Range Hoods.

### Venting Requirements

4. The range hood has top 6" round exhaust (default).
5. Decided the location of the venting pipe from the hood to the outside. A straight, short vent run will allow the hood to perform more efficiently. Try to avoid elbows, transitions, and long run as much as possible as this may reduce the performance of the hood. Make sure that the duct work leads to the outside.
6. It is recommended to use metal/aluminum duct/pipe with a uniform size (ex. 6" round pipe from range hood to the outside).

7. If an elbow is necessary, a minimum of 12" straight run is necessary before the elbow.

### Clearance

8. Clearance is the distance between the cooktop and the bottom of the range hood. The recommended minimum clearance for this model is 26" and the maximum clearance is 30".
9. It is important to install the hood at the recommended clearance. Installing too low could result in damage and/or fire hazard while installing too high may result in reduced performance and efficiency.

### Hood Installation

10. Prepare back wall frame with cross framing lumber for secure installation if necessary. Using references on TABLE 1 and measurements on page XX to decide the level of the lumber. Refer to Figure 1.
11. Mark the leveling point of the hood. Position two 4\*35 screws on the wall, leaving 1/8" away from the wall as shown in Figure 2.
12. Align hood-mounting bracket to the two screws on the wall and hook the hood into place. Tighten screws to secure hood to the wall. Refer to Figure 3.

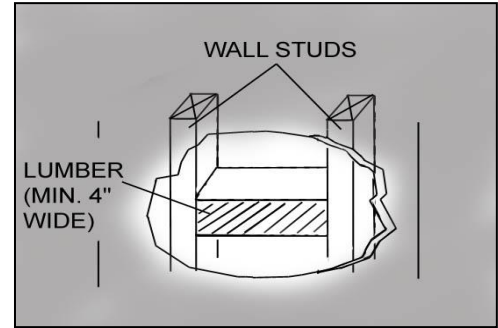

Figure 1

### Ductwork

13. Put the two flappers on 6" round exhaust vent adapter. NOTE: striped side of the flapper is facing out.
14. Attached the rubber plate to the bottom of 6" round exhaust vent adapter then attached to the exhaust opening and use six 4\*6 screws to secure it.
15. Use 6" round steel pipe (not included) to connect the 6" round exhaust on the hood to the ductwork above. Use duct tape to make all joints secure and air tight.



Figure 2

### Duct Cover Installation

16. Use reference E from TABLE 1 and measurements on page XX to mark the position of the duct cover-mounting bracket.
17. Secure the duct cover-mounting bracket to the wall with two 4\*35 screws. Make sure all screws are tightened. Refer to Figure 4. NOTE: Inner duct cover will cover the duct cover-mounting bracket.
18. Put the entire duct cover onto the hood. Secure the outer duct cover with two 4\*8 screws to the hood-mounting bracket. Refer to Figure 5.
19. Slide the inner duct cover until it reaches to the duct cover-mounting bracket. Secure inner duct cover with two 4\*8 screws to the duct cover-mounting bracket. Shown in Figure 6.

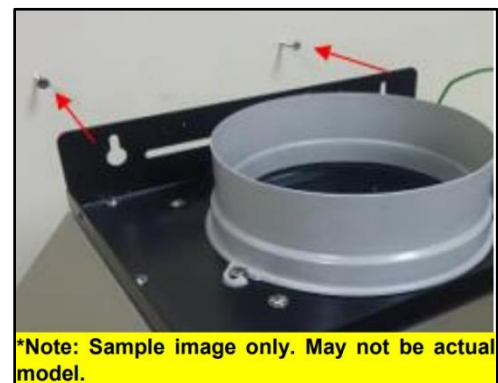

Figure 3



## Electrical Wire

20. Connect the range hood to an outlet.
21. If hardwire is desired, cut off the plug and connect three wires (black, white, and green) to the outlet wires and cap with wire connectors. Connect the wires according to color (ex. black to black).

## Finish

22. Remove any protective film from the hood, if any.
23. Before using, make sure that any accessories such as baffle filters are properly installed where applicable.
24. Test the range hood to see if it is working properly.

**⚠ THIS RANGE HOOD MUST BE PROPERLY GROUNDED. MAKE SURE THIS IS DONE BY QUALIFIED ELECTRICIAN IN ACCORDANCE WITH ALL APPLICABLE NATIONAL AND LOCAL ELECTRICAL CODES. BEFORE CONNECTING WIRES, SWITCH POWER OFF AT SERVICE PANEL AND LOCK SERVICE TO PREVENT POWER FROM BEING SWITCHED ON ACCIDENTALLY.**



Figure 4

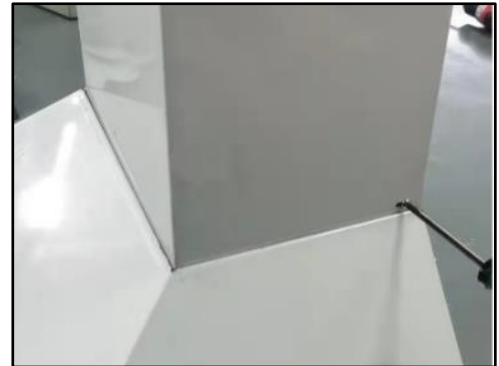

Figure 5



Figure 6

## OPERATING INSTRUCTIONS

### 3-Speed Rocker Switch

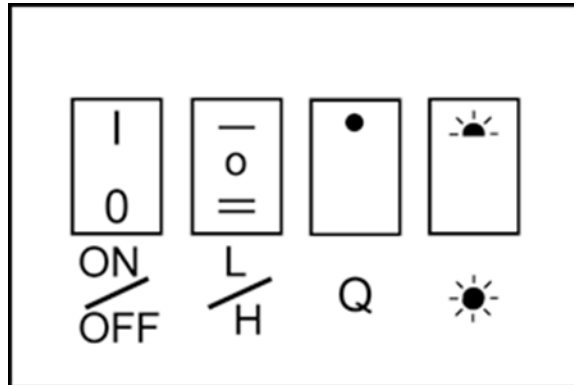

NOTE: For best result, turn fan on prior to any preparation or cooking and keep fans running while cooking. Adjust speed as needed.

#### **To operate the fan function**

- Press ON/OFF Control to turn on the power.
- Once the ON/OFF Control is turned on, the prior fan selection will turn on. Press the Speed Controls (Low, High or QuietMode™) to select the desired speed.
- QuietMode™ supersedes all other fan control. Turn off QuietMode™ to use Low or High Speed.
- Press ON/OFF Control to turn fan off.

#### **To operate the light function**

- Press ON/OFF Control to turn on the power.
- Press the Light Control to turn lights on and off.

NOTE: The Power Control Switch is the main power controller.

## MAINTENANCE

For optimal performance, clean the range hood surface and filters regularly.

### To Clean Hood Surface

**CAUTION: NEVER USE ABRASIVE CLEANERS, PADS, OR CLOTHS.**

\*\*\*Regular care will help preserve its fine appearance.

1. Use only mild soap or detergent solutions. Dry surfaces using soft cloth.
2. If hood looks smudged (stainless steel hood), use a stainless steel cleaner to clean the surface of the hood. Avoid getting cleaning solution onto or into the control panel. Follow directions of the stainless steel cleaner. **Caution: Do not leave on too long as this may cause damage to hood finish.** Use soft towel to wipe off the cleaning solution, gently rub off any stubborn spots. Use dry soft towel to dry the hood.
3. DO NOT allow deposits to accumulate or remain on the hood.
4. DO NOT use ordinary steel wool or steel brushes. Small bits of steel may adhere to the surface and cause rusting.
5. DO NOT allow salt solutions, disinfectants, bleaches, or cleaning compounds to remain in contact with stainless steel for extended periods. Many of these compounds contain chemicals, which may be harmful to the hood. Rinse with water after exposure and wipe dry with a clean lint free cloth.

### For Baffle Filter models only: to Clean Baffle Filters / Oil Tunnel

**CAUTION: DRAIN OIL FROM BAFFLE FILTERS, SPACERS & OIL TUNNEL REGULARLY TO PREVENT OVERFLOW.**

1. Remove all the baffle filters, spacers and oil tunnel. NOTE: Not all models have spacers and oil tunnel.
2. Using a sponge, wash with warm soapy water. Dry completely before returning into place.

**CAUTION: SHARP EDGES**

*(NOTE: Baffle Filters are top rack dishwasher safe)*

## SPECIFICATIONS

<b>MODEL / SIZE</b>	CHX8130SQB-1 / 30" CHX8136SQB-1 / 36"		
	CHX8130SQB-2 / 30" CHX8136SQB-2 / 36"		
<b>COLOR</b>	Commercial Grade Stainless Steel		
<b>CONSUMPTION / AMPERE</b>	126W / 1.41A		
<b>VOLTAGE / Hz</b>	110V / 60Hz		
<b>NUMBER OF BLOWERS</b>	1		
<b>DESIGN</b>	Seamless with Satin Finish		
<b>BLOWER TYPE</b>	Single Horizontal Squirrel Cage		
<b>EXHAUST</b>	Top 6" Round		
<b>CONTROL</b>	Rocker Switch		
<b>LIGHT</b>	3-watt LED Light x 2		
<b>HOOD DIMENSION (W x D x H)</b>	<b>CHX8130SQB-1</b>	29-3/4" x 19-11/16" x (28-3/8"~41-3/8")	
	<b>CHX8136SQB-1</b>	35-3/4" x 19-11/16" x (28-3/8"~41-3/8")	
	<b>CHX8130SQB-2</b>	29-3/4" x 19-11/16" x (28-3/8"~41-3/8")	
	<b>CHX8136SQB-2</b>	35-3/4" x 19-11/16" x (28-3/8"~41-3/8")	
<b>OPTIONAL ACCESSORIES (W x D x H)</b>	<b>1. 30" Stainless Steel Back Panel</b> Model: SSP30 (30" x 32" x 1/10") <b>2. 36" Stainless Steel Back Panel</b> Model: SSP36 (36" x 32" x 1/10")		
<b>HOOD WEIGHT</b>		<u>Net</u>	<u>Gross</u>
	CHX8130SQB-1 (30")	34.4 lbs	45.0 lbs
	CHX8136SQB-1 (36")	37.5 lbs	49.0 lbs
	CHX8130SQB-2 (30")	37.0 lbs	45.0 lbs
	CHX8136SQB-2 (36")	41.0 lbs	49.0 lbs
<b>SPEED</b>	<u>QuietMode™</u>	<u>Low</u>	<u>High</u>
<b>Air Capacity (cfm)</b>	237	386	700
<b>Decibel</b>	59	67	75

\*One sone is equivalent to the sound of a refrigerator at 40 decibels.

\*\*Specifications subject to change without notice.

# MEASUREMENTS & DIAGRAMS

\*\*\*All inch measurements are converted from millimeters. Inch measurements are estimated.

\*\*\*All measurements in ( ) are millimeters.

**MODEL NO.: CHX8130SQB-1 (30") / CHX8136SQB-1 (36")**  
**CHX8130SQB-2 (30") / CHX8136SQB-2 (36")**

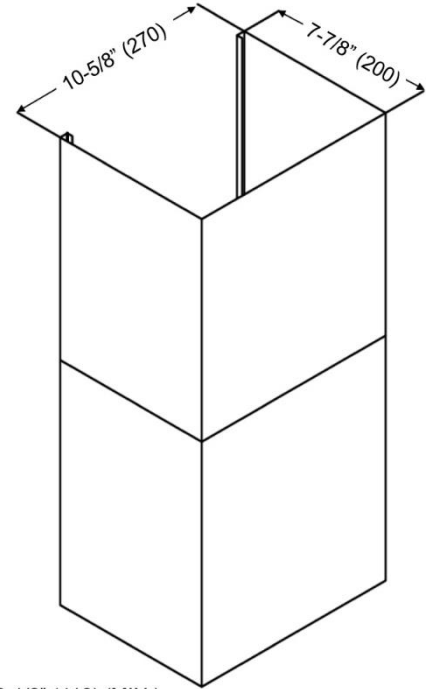
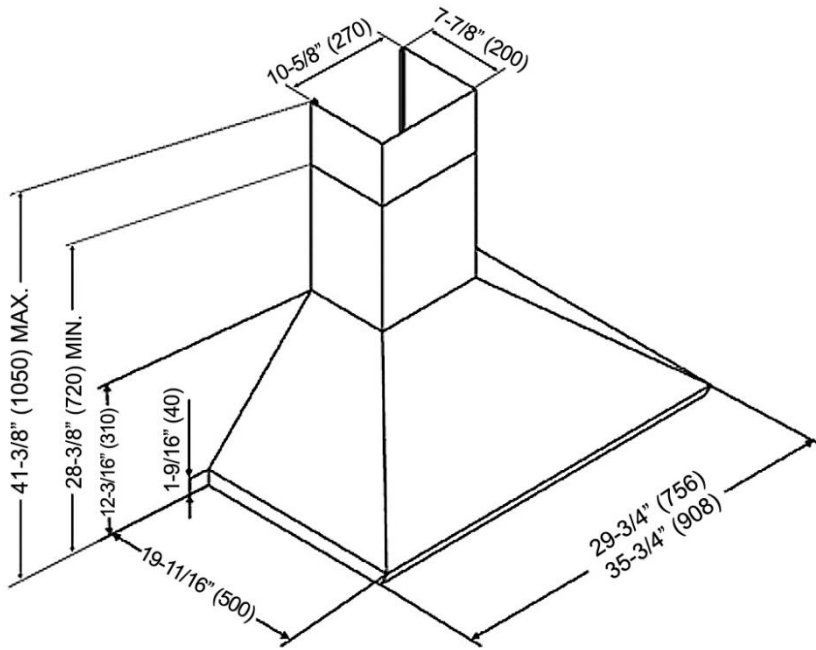

Inner: 15" (380)  
 Outer: 15" (380)

Dimension: 16-1/8" (410) (MIN.)  
 29-1/8" (740) (MAX.)

**Front View**

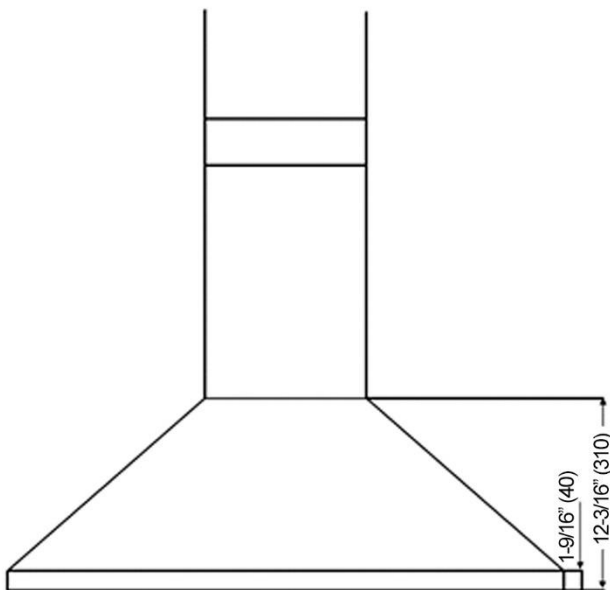

**Bottom View**

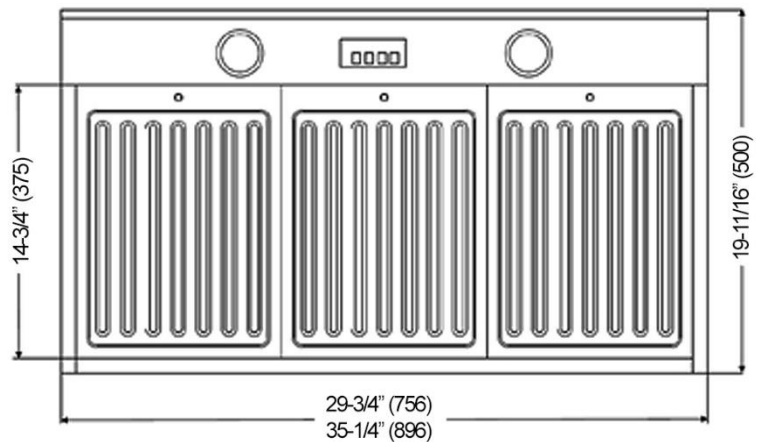

# PARTS LIST

MODEL NO.: CHX8130SQB-1 (30") / CHX8136SQB-1 (36")  
 CHX8130SQB-2 (30") / CHX8136SQB-2 (36")

No.	Description	Model No.	Part No.
01	Duct Cover Mounting Bracket		02-027
02	Duct Cover		CHX81DC-2
03	Capacitor		02-004
04	LED Light		02-005
05	Rocker Switch Set		02-025
06	Blower System		YYC-148-3
07	Baffle Filter (283mm x 374mm)		02-026
08	6" Round Exhaust Adapter		02-003
09	LED Light Driver		02-001

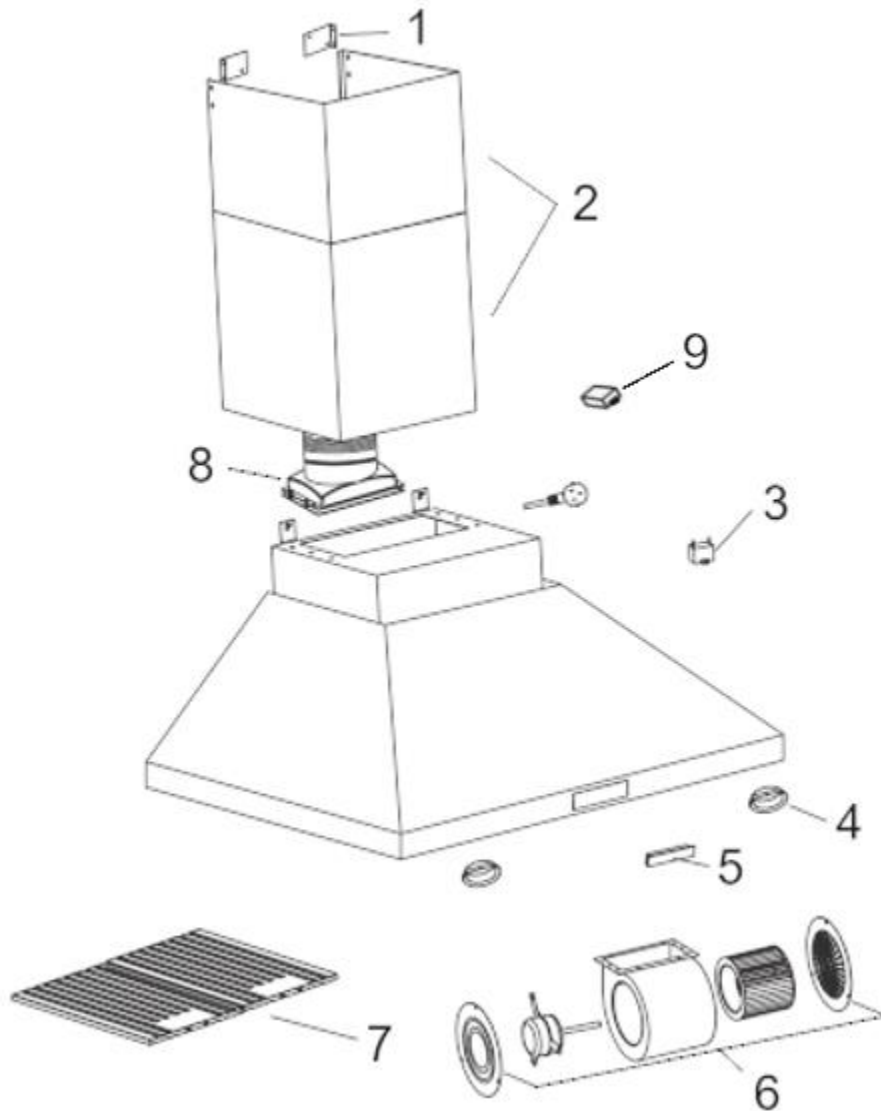

# CIRCUIT DIAGRAM

MODEL NO.: CHX8130SQB-1 (30") / CHX8136SQB-1 (36")  
CHX8130SQB-2 (30") / CHX8136SQB-2 (36")

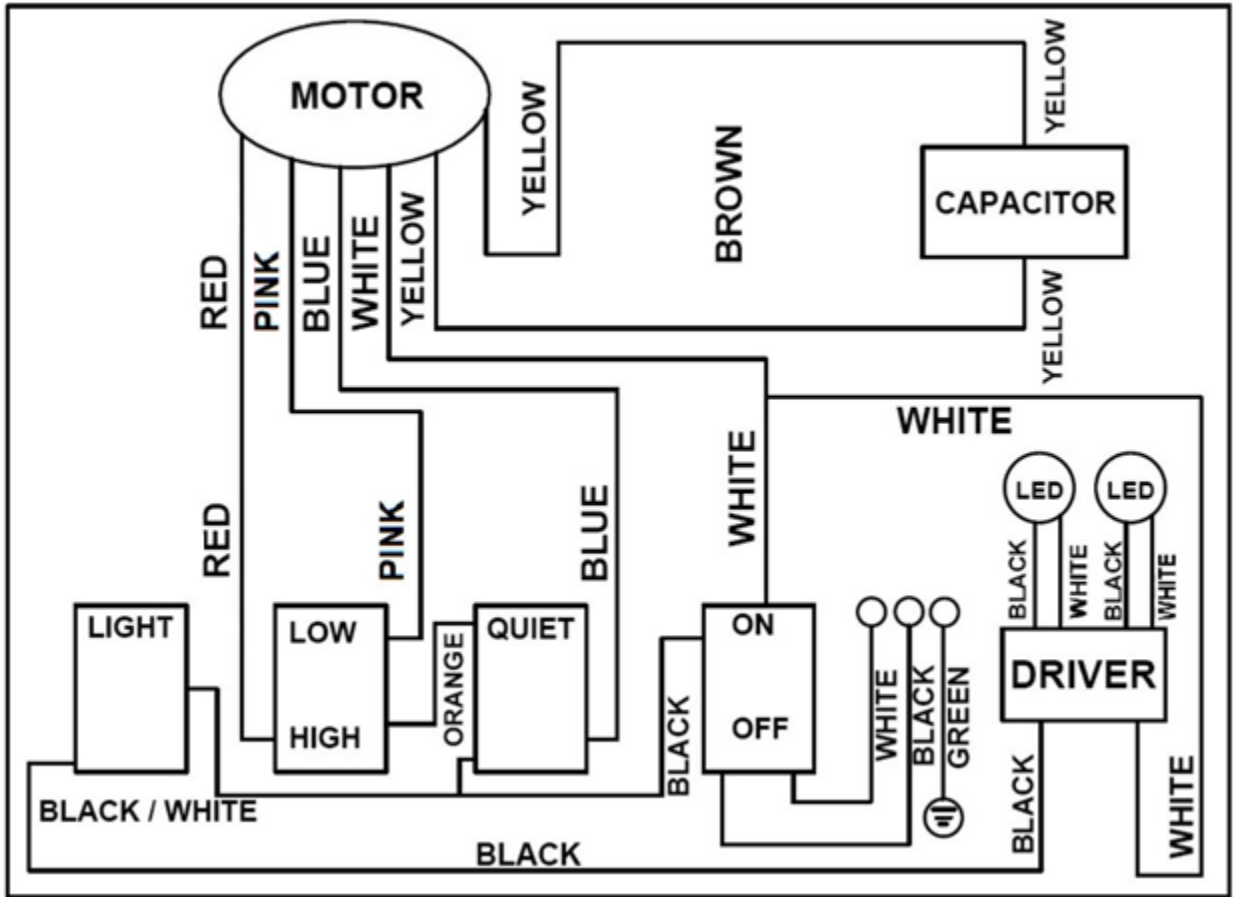

## TROUBLE SHOOTING

Issue	Possible Cause	Solution
After installation, both motors and lights are not working.	The power is not on.	Make sure the circuit breaker and the unit's power is ON. Use a voltage meter to check the power supply.
	The wire connection is not secure.	Check and tighten wire connection.
	The control panel is defective.	Replace the control panel.
Lights are working, but motor(s) is not.	The motor(s) is defective.	Replace the motor(s).
	The capacitor(s) is defective.	Replace the capacitor(s).
	The control panel is defective.	Replace the control panel.
The range hood is vibrating.	The blower system is not secure.	Tighten the squirrel cage and air chamber.
	The squirrel cage is not balanced.	Replace the squirrel cage.
	Hood is not secured in place.	Check the installation of hood, tighten the mounting bracket.
The motor is working, but the lights are not working	LED(s) is defective.	Replace the LED(s).
	The light wiring(s) is loose.	Check wire continuity from light transformer to light housing(s).
	Light driver is defective.	Check power input and power output on the light driver. If it's needed, replace the light driver.
	The control panel is defective.	Replace the control panel.
The range hood is not venting out correctly.	The range hood is installed outside of the manufacturer recommended clearance.	Adjust the clearance between the range hood and cook top to 26" to 30". For island range hood, the clearance between the range hood and cook top is 30" to 36".
	There is no make-up air inside the house.	Open the window to enhance the performance of the range hood by creating a sufficient make-up air.
	Obstacle blocking the pipe work	Remove all obstacles from the duct work.
	The pipe size is smaller than the suggested pipe size.	Change the ducting according to the manufacturer suggestion.
Cold air is coming into the home.	The pipe connection is not properly sealed.	Check the pipe installation.
	The damper is not properly installed or is missing from the installation.	Check the damper installation.
	The damper is not installed.	By installing the damper, it will help to eliminate air backflow.



## WARRANTY

### WARRANTY CERTIFICATE

**In order to obtain warranty service, you must provide proof of original purchase from a KOBE authorized dealer. Please keep a copy of your original invoice as proof of purchase.**

#### **TWO-YEAR LIMITED PARTS WARRANTY ON KOBE BRILLIA SERIES:**

For two years from the date of your original invoice from a KOBE authorized dealer, we will provide non-consumable replacement parts or components free of charge that failed due to manufacturing defects. Consumable parts such as light bulbs, filters, fuses, and oil cups are not covered by this warranty.

KOBE reserves the right to replace, rather than send out replacement parts of the product free of charge at our sole discretion.

#### **WHAT IS COVERED:**

This warranty is valid in the United States and Canada. It is non-transferable and applies only to the original purchaser and does not extend to any subsequent owners of this product. In Hawaii, Alaska, and Canada, this warranty is limited. There may be additional shipping charges for parts and service technician travel costs in remote areas or locations 30 miles outside of KOBE authorized service areas.

#### **WHAT IS NOT COVERED:**

1. Normal wear and tear, regular service and maintenance required for the product.
2. Consumable parts such as light bulbs, filters, fuses, and oil cups.
3. Chips, scratches, or dents due to abuse or misuse of the product, use of corrosive and abrasive cleaning products.
4. Damages caused by accident, fire, flood and other Acts of God.
5. Services in remote areas or locations 30 miles outside of KOBE authorized service areas.
6. Labor cost incurred in connection with the removal of range hood, and installation of replacement range hood, nor does it cover any other contingent expenses.
7. Scratches inside the hood, back of the baffle filter, and inside the duct cover.

**THIS WARRANTY WILL BE VOIDED BY:**

1. Improper installation and failure to follow installation instructions.
2. Any repair, alternation, modification not authorized by KOBE.
3. Duct alternation, modification, and connection.
4. Incorrect electric current, voltage, or wiring.
5. Improper usage of the product such as commercial, outdoor, or other usage other than residential indoor usage.
6. Purchasing this product from an unauthorized KOBE dealer.
7. Damaging the product due to negligence, misuse, abuse, or accident.

If we determine that the warranty exclusions listed above applies or if you fail to provide all necessary documentation for warranty service, you will be responsible for all expenses associated with the requested service, including parts, labor, shipping, traveling, and any other expense related to the service request.

**TO REQUEST WARRANTY SERVICE, PLEASE CONTACT KOBE RANGE HOODS SERVICE CENTER:**

**From the 48 contiguous states:**

Email (best): [customer.service@koberangehoods.com](mailto:customer.service@koberangehoods.com)

**From Alaska, Hawaii, and Canada:**

Email (best): [customer.service@koberangehoods.com](mailto:customer.service@koberangehoods.com)

## WARRANTY INFORMATION FORM

Fills in the blanks and keep this paper with the **original invoice** in a safe place for future service purpose.

1. Date of purchase : \_\_\_\_\_

2. Model No. : \_\_\_\_\_

3. Serial No. : \_\_\_\_\_

**For warranty service or spare parts purchase in US, contact:**

KOBE Service Center

Email (best): [customer.service@koberangehoods.com](mailto:customer.service@koberangehoods.com)

**For warranty service or spare parts purchase in Canada, contact:**

Email (best): [customer.service@koberangehoods.com](mailto:customer.service@koberangehoods.com)

Your Notes:

# KOBE®

KOBE Range Hoods  
11775 Clark Street  
Arcadia, CA 91006 USA

[www.koberangehoods.com](http://www.koberangehoods.com)

This KOBE hood is made for use in the USA and CANADA only. We do not recommend using this hood overseas as the power supply may not be compatible and may violate the electrical code of that country. **Using a KOBE hood overseas is at your own risk and will void your warranty.**

Cette hotte KOBE est fabriquée pour usage aux États-Unis et au Canada seulement. Il n'est pas recommandé d'utiliser cette hotte à l'étranger puisque l'alimentation électrique pourrait ne pas être compatible et enfreindre le code de l'électricité de ce pays. **L'usage de la hotte KOBE à l'étranger est à votre propre risque et la garantie sera annulée.**

Esta campana de extracción KOBE ha sido fabricada para ser utilizada únicamente en EE.UU. y CANADÁ. No recomendamos la utilización de esta campana en el extranjero debido a que la fuente de energía podría no ser compatible y podría violar el código eléctrico de dicho país. **Utilizar una campana KOBE en el extranjero será a su propio riesgo y anulará la garantía.**

VER. 250318

Information subject to change without notice.